



standardpro.com

STANPRO



CHOICE SERIES E-LUME

QUICK SHIP



STANPRO



Printed in Canada.

© 2021 STANDARD Products Inc. All Rights Reserved.

Data is based upon tests performed in a controlled environment.
Actual performance can vary depending on operating conditions.
All products are subject to change or may be discontinued any time without notice.

For the latest version, please refer to our website.

www.standardpro.com



STANPRO

Choice Series

5 LED LAMP

T8, High Bay Retrofit, PAR20, PAR30SN, PAR30LN, PAR38, GU10, MR16, MR16E26, A19

8 LED DOWNLIGHT

LPDL™, Swivel

12 LED PANEL

14 LED MINI FLOOD

E-Lume™

19 RECESSED FIXTURE

22 INCANDESCENT LAMP

BR30, G16.5, G25, R16, R20

23 COMPACT FLUORESCENT LAMP

PAR20, T2 Spirals, 2-pin Double Twin Tube, 4-pin Double Twin Tube

24 HID LAMP

Pulse Start

25 FLUORESCENT LAMP

T8 Preheat Start, T8 800 Sries, T5 Preheat Start, T5 Program Start, T5 HO Program Start



Choice Series

Standard is proud to introduce its Choice line of LED lamps, focusing on efficiency and value. You will always find the right Choice in this line!

LED Lamp

- Ballast compatible T8 lamp offer a quick and economical solution without any additional wiring needed.
- Quality glass encasing ensures protection against tube yellowing and brittleness.
- Compatible with a variety of electronic instant start ballasts.



| Order code | Description | System watts (W) | | | Base | Color temp. (K) | CRI | Life L70 (hrs) | Lumen output (lm) | | | Case qty (master) |
|-----------------------------------|-------------------------------|------------------|------------------|------------------|------|-----------------|-----|----------------|-------------------|------------------|------------------|-------------------|
| | | LBF ¹ | NBF ¹ | HBF ¹ | | | | | LBF ¹ | NBF ¹ | HBF ¹ | |
| T8 4' - Ballast Compatible | | | | | | | | | | | | |
| 67972 | T8/S2/10.5W/835/48/CHOICE/STD | 11.5 | 13 | 17 | G13 | 3 500 | 80 | 50 000 | 1 600 | 1 800 | 2 400 | 25 |
| 67973 | T8/S2/10.5W/840/48/CHOICE/STD | 11.5 | 13 | 17 | G13 | 4 000 | 80 | 50 000 | 1 600 | 1 800 | 2 400 | 25 |
| 67977 | T8/S2/10.5W/850/48/CHOICE/STD | 11.5 | 13 | 17 | G13 | 5 000 | 80 | 50 000 | 1 600 | 1 800 | 2 400 | 25 |

Lumen values are derived from photometric testing
 For a complete list of compatible dimmers and energy start qualified products, please visit www.standardpro.com
 This lamp only operates on existing ballast in 120-277/347 V application
 1 LBF= Low ballast factor, NBF= Normal ballast factor, HBF= High ballast factor
 2 Not DLC



enclosed fixture



non dimmable



- High intensity LED lamp for high bay luminaire retrofit application.
- Simple ballast bypass installation – no need for a time consuming fixture replacement.
- Heatsink designed for optimal heat dissipation.
- Replaces a 400W HID lamp.



| Order code | Description | Watts | Base | Volts | Color temp. (K) | CRI | Life L70 (hrs) | Bare lamp lumen (lm) | Operating position | Case qty (master) |
|------------|--|-------|------|---------|-----------------|-----|----------------|----------------------|--------------------|-------------------|
| | | (W) | | (VAC) | | | | | | |
| 67660 | CRNHB/160W/40K/BYP/120-277/ND/CHOICE/STD | 160 | EX39 | 120-277 | 4 000 | 83 | 50 000 | 20 000 | Vertical | 4 |

Lumen values are derived from photometric testing
 For a complete list of compatible dimmers and DLC qualified products, please visit www.standardpro.com
¹ These products comply with UL1598C Standard for LED luminaire Retrofit kits



non dimmable





| Order code | Description | Watts (W) | Base | Volts (VAC) | Color temp. (K) | CRI | Life L70 (hrs) | Lumen output (lm) | Beam angle (°) | CBCP (cd) | Traditional equivalent (W) | Case qty (master) |
|--------------------|-----------------------------|-----------|------|-------------|-----------------|-----|----------------|-------------------|----------------|-----------|----------------------------|-------------------|
| PAR20 | | | | | | | | | | | | |
| 66279 ¹ | P20/8W/27K/25/CHOICE/STD | 8 | E26 | 120 | 2 700 | ≥90 | 15 000 | 581 | 25 | 1 708 | 50 | 12 |
| 66280 ¹ | P20/8W/27K/40/CHOICE/STD | 8 | E26 | 120 | 2 700 | ≥90 | 15 000 | 572 | 40 | 914 | 50 | 12 |
| 66281 ¹ | P20/8W/30K/25/CHOICE/STD | 8 | E26 | 120 | 3 000 | ≥90 | 15 000 | 608 | 25 | 1 708 | 50 | 12 |
| 66282 ¹ | P20/8W/30K/40/CHOICE/STD | 8 | E26 | 120 | 3 000 | ≥90 | 15 000 | 605 | 40 | 914 | 50 | 12 |
| 66283 ¹ | P20/8W/40K/25/CHOICE/STD | 8 | E26 | 120 | 4 000 | ≥90 | 15 000 | 616 | 25 | 1 708 | 50 | 12 |
| 66284 ¹ | P20/8W/40K/40/CHOICE/STD | 8 | E26 | 120 | 4 000 | ≥90 | 15 000 | 652 | 40 | 914 | 50 | 12 |
| PAR30SN | | | | | | | | | | | | |
| 66291 | P30S/12W/27K/25/CHOICE/STD | 12 | E26 | 120 | 2 700 | ≥90 | 15 000 | 934 | 25 | 3 843 | 75 | 6 |
| 66292 | P30S/12W/27K/40/CHOICE/STD | 12 | E26 | 120 | 2 700 | ≥90 | 15 000 | 929 | 40 | 1 740 | 75 | 6 |
| 66293 | P30S/12W/30K/25/CHOICE/STD | 12 | E26 | 120 | 3 000 | ≥90 | 15 000 | 965 | 25 | 3 843 | 75 | 6 |
| 66294 | P30S/12W/30K/40/CHOICE/STD | 12 | E26 | 120 | 3 000 | ≥90 | 15 000 | 922 | 40 | 1 740 | 75 | 6 |
| 66295 | P30S/12W/40K/25/CHOICE/STD | 12 | E26 | 120 | 4 000 | ≥90 | 15 000 | 1 006 | 25 | 3 843 | 75 | 6 |
| 66296 | P30S/12W/40K/40/CHOICE/STD | 12 | E26 | 120 | 4 000 | ≥90 | 15 000 | 977 | 40 | 1 740 | 75 | 6 |
| PAR30LN | | | | | | | | | | | | |
| 66285 | P30L/12W/27K/25/CHOICE/STD | 12 | E26 | 120 | 2 700 | ≥90 | 15 000 | 942 | 25 | 4 178 | 75 | 6 |
| 66286 | P30L/12W/27K/40/CHOICE/STD | 12 | E26 | 120 | 2 700 | ≥90 | 15 000 | 935 | 40 | 1 813 | 75 | 6 |
| 66287 | P30L/12W/30K/25/CHOICE/STD | 12 | E26 | 120 | 3 000 | ≥90 | 15 000 | 974 | 25 | 4 178 | 75 | 6 |
| 66288 | P30L/12W/30K/40/CHOICE/STD | 12 | E26 | 120 | 3 000 | ≥90 | 15 000 | 935 | 40 | 1 813 | 75 | 6 |
| 66289 | P30L/12W/40K/25/CHOICE/STD | 12 | E26 | 120 | 4 000 | ≥90 | 15 000 | 1 024 | 25 | 4 178 | 75 | 6 |
| 66290 | P30L/12W/40K/40/CHOICE/STD | 12 | E26 | 120 | 4 000 | ≥90 | 15 000 | 996 | 40 | 1 813 | 75 | 6 |
| PAR38 | | | | | | | | | | | | |
| 66297 | P38/16.5W/27K/25/CHOICE/STD | 16.5 | E26 | 120 | 2 700 | ≥90 | 15 000 | 1 360 | 25 | 6 067 | 100 | 6 |
| 66298 | P38/16.5W/27K/40/CHOICE/STD | 16.5 | E26 | 120 | 2 700 | ≥90 | 15 000 | 1 398 | 40 | 2 527 | 100 | 6 |
| 66299 | P38/16.5W/30K/25/CHOICE/STD | 16.5 | E26 | 120 | 3 000 | ≥90 | 15 000 | 1 419 | 25 | 6 067 | 100 | 6 |
| 66300 | P38/16.5W/30K/40/CHOICE/STD | 16.5 | E26 | 120 | 3 000 | ≥90 | 15 000 | 1 355 | 40 | 2 527 | 100 | 6 |
| 66301 | P38/16.5W/40K/25/CHOICE/STD | 16.5 | E26 | 120 | 4 000 | ≥90 | 15 000 | 1 548 | 25 | 6 067 | 100 | 6 |
| 66302 | P38/16.5W/40K/40/CHOICE/STD | 16.5 | E26 | 120 | 4 000 | ≥90 | 15 000 | 1 510 | 40 | 2 527 | 100 | 6 |

Lumen values are derived from photometric testing
 For a complete list of compatible dimmers and ENERGY STAR qualified products, please visit
www.standardpro.com





GU10



MR16



MR16
E26



A19



A19 4 pack

| Order code | Description | Watts (W) | Base | Volts (VAC) | Color temp. (K) | CRI | Life L70 (hrs) | Lumen output (lm) | Beam angle (°) | CBCP (cd) | Traditional equivalent (W) | Dimming capability (Yes/No) | Case qty (inner/master) |
|---|----------------------------------|-----------|-------|-------------|-----------------|-----|----------------|-------------------|----------------|-----------|----------------------------|-----------------------------|-------------------------|
| GU10 | | | | | | | | | | | | | |
| 66304 | GU10/6.5W/27K/40/CHOICE/STD | 6.5 | GU10 | 120 | 2 700 | ≥80 | 15 000 | 500 | 40 | 778 | 50 | Yes | 1/24 |
| 66306 | GU10/6.5W/30K/40/CHOICE/STD | 6.5 | GU10 | 120 | 3 000 | ≥80 | 15 000 | 500 | 40 | 778 | 50 | Yes | 1/24 |
| 66308 | GU10/6.5W/40K/40/CHOICE/STD | 6.5 | GU10 | 120 | 4 000 | ≥80 | 15 000 | 500 | 40 | 778 | 50 | Yes | 1/24 |
| MR16³ | | | | | | | | | | | | | |
| 66309 | MR16/12V/6.5W/27K/35/CHOICE/STD | 6.5 | GU5.3 | 12 | 2 700 | ≥80 | 25 000 | 500 | 35 | 1 772 | 50 | Yes | 1/24 |
| 66310 | MR16/12V/6.5W/30K/35/CHOICE/STD | 6.5 | GU5.3 | 12 | 3 000 | ≥80 | 25 000 | 500 | 35 | 1 772 | 50 | Yes | 1/24 |
| 66311 | MR16/12V/6.5W/40K/35/CHOICE/STD | 6.5 | GU5.3 | 12 | 4 000 | ≥80 | 25 000 | 500 | 35 | 1 772 | 50 | Yes | 1/24 |
| MR16-E26 | | | | | | | | | | | | | |
| 66354 | MR16E26/7W/30K/35/CHOICE/STD | 7 | E26 | 120 | 3 000 | 82 | 15 000 | 500 | 35 | 1 321 | 50 | Yes | 6/48 |
| A19 | | | | | | | | | | | | | |
| Energy Star & Enclosed rated | | | | | | | | | | | | | |
| 66267 | A19/6W/27K/ND/CHOICE/STD | 6 | E26 | 120 | 2 700 | ≥80 | 15 000 | 480 | - | - | 40 | No | 6/48 |
| 66268 | A19/6W/30K/ND/CHOICE/STD | 6 | E26 | 120 | 3 000 | ≥80 | 15 000 | 480 | - | - | 40 | No | 6/48 |
| 68593 | A19/S3/9.5W/27K/ND/CHOICE/STD | 9.5 | E26 | 120 | 2 700 | ≥80 | 15 000 | 800 | - | - | 60 | No | 6/48 |
| 66270 | A19/9.5W/30K/ND/CHOICE/STD | 9.5 | E26 | 120 | 3 000 | ≥80 | 15 000 | 800 | - | - | 60 | No | 6/48 |
| A19 | | | | | | | | | | | | | |
| Not Energy Star, Not suitable for enclosed fixture² | | | | | | | | | | | | | |
| 67964 | A19/S2/6W/27K/ND/CHOICE/STD | 6 | E26 | 120 | 2 700 | 80 | 15 000 | 480 | 180 | - | 40 | No | 1/100 |
| 67965 | A19/S2/6W/30K/ND/CHOICE/STD | 6 | E26 | 120 | 3 000 | 80 | 15 000 | 480 | 180 | - | 40 | No | 1/100 |
| 67966 | A19/S2/9W/27K/ND/CHOICE/STD | 9 | E26 | 120 | 2 700 | 80 | 15 000 | 480 | 180 | - | 60 | No | 1/100 |
| 67967 | A19/S2/9W/30K/ND/CHOICE/STD | 9 | E26 | 120 | 3 000 | 80 | 15 000 | 800 | - | - | 60 | No | 1/100 |
| A19 4 Pack | | | | | | | | | | | | | |
| Energy Star & Enclosed rated | | | | | | | | | | | | | |
| 68594 | A19/S3/9.5W/27K/ND/CHOICE/STD 4P | 9.5 | E26 | 120 | 2 700 | ≥80 | 15 000 | 800 | - | - | 60 | No | 1/12 |
| 66272 | A19/9.5W/30K/ND/CHOICE/STD 4P | 9.5 | E26 | 120 | 3 000 | ≥80 | 15 000 | 800 | - | - | 60 | No | 1/12 |
| 66273 | A19/9.5W/40K/ND/CHOICE/STD 4P | 9.5 | E26 | 120 | 4 000 | ≥80 | 15 000 | 800 | - | - | 60 | No | 1/12 |
| 68595 | A19/S3/9.5W/50K/ND/CHOICE/STD 4P | 9.5 | E26 | 120 | 5 000 | ≥80 | 15 000 | 800 | - | - | 60 | No | 1/12 |
| A19 4 Pack | | | | | | | | | | | | | |
| Not Energy Star, Not suitable for enclosed fixture² | | | | | | | | | | | | | |
| 67968 | A19/S2/9W/27K/ND/CHOICE/STD 4P | 9 | E26 | 120 | 2 700 | 80 | 15 000 | 800 | 180 | - | 60 | No | 4/100 |
| 67969 | A19/S2/9W/30K/ND/CHOICE/STD 4P | 9 | E26 | 120 | 3 000 | 80 | 15 000 | 800 | 180 | - | 60 | No | 4/100 |
| 67970 | A19/S2/9W/40K/ND/CHOICE/STD 4P | 9 | E26 | 120 | 4 000 | 80 | 15 000 | 800 | 180 | - | 60 | No | 4/100 |
| 67971 | A19/S2/9W/50K/ND/CHOICE/STD 4P | 9 | E26 | 120 | 5 000 | 80 | 15 000 | 800 | 180 | - | 60 | No | 4/100 |

Lumen values are derived from photometric testing
 For a complete list of compatible dimmers, and energy star qualified products, please visit www.standardpro.com

² 2 year warranty.

³ Not Energy Star





LED Downlight

LPDL™

The LED downlight LPDL Choice gives you all the flexibility you need during installation, especially in confined areas or when facing constraints such as wood beams, ceiling joist or air ducts.

The driver is mounted separately from the light source which allows the luminaire profile to be less than 1" thick!



| Order code | Model number | Watts (W) | Volts (VAC) | Color temp. (K) | Lumen output (lm) | Efficiency (lm/W) | CRI | Life L70 (hrs) | Beam angle (°) | Cable rating | Finish | Dimming (Yes/No) | Power factor | THD (%) | Traditional equivalent (W) | Case qty (master) |
|---|---------------------------------|-----------|-------------|-------------------|-------------------|-------------------|-----|----------------|----------------|--------------|----------------|------------------|--------------|---------|----------------------------|-------------------|
| 4" Round Single CCT | | | | | | | | | | | | | | | | |
| 68304 | LPDL4R-11A-30WH/CHOICE | 11 | 120 | 3 000 | 750 | 68 | 80+ | 50 000 | 100 | FT4 | White | Yes | >0.9 | <15 | 60 | 32 |
| 67932 | LPDL4/RND/11W/30K/BN/CHOICE/STD | 11 | 120 | 3 000 | 700 | 64 | 80+ | 50 000 | 100 | FT4 | Brushed Nickel | Yes | >0.9 | <15 | 60 | 32 |
| 67933 | LPDL4/RND/11W/40K/BN/CHOICE/STD | 11 | 120 | 4 000 | 700 | 64 | 80+ | 50 000 | 100 | FT4 | Brushed Nickel | Yes | >0.9 | <15 | 60 | 32 |
| Bulk pack of 10 units single CCT | | | | | | | | | | | | | | | | |
| 68310 | LPDL4R-11A-30WH/CHOICE 10P | 11 | 120 | 3 000 | 750 | 68 | 80+ | 50 000 | 100 | FT4 | White | Yes | >0.9 | <15 | 60 | 40 |
| CCT Selectable | | | | | | | | | | | | | | | | |
| 68305 | LPDL4R-11A-3CWH/CHOICE | 11 | 120 | 2 700/3 000/4 000 | 750 | 63 | 80+ | 50 000 | 100 | FT4 | White | Yes | >0.9 | <15 | 60 | 32 |
| 68308 | LPDL4R-11A-3CBN/CHOICE | 11 | 120 | 2 700/3 000/4 000 | 750 | 63 | 80+ | 50 000 | 100 | FT4 | Brushed Nickel | Yes | >0.9 | <15 | 60 | 32 |
| 6" Round CCT Selectable | | | | | | | | | | | | | | | | |
| 68309 | LPDL6R-14A-3CWH/CHOICE | 14 | 120 | 2 700/3 000/4 000 | 1 100 | 71 | 80+ | 50 000 | 100 | FT4 | White | Yes | >0.9 | <15 | 60 | 18 |

Typical color temperature range: +/- 5 %.

Lumen values are derived from Energy Star reported data. Initial lumens range: +/- 10 %.

Life hours are derived from IESNA LM-80-08 testing report and projected per IESNA TM-21-11 extrapolations.

Dimensions

4"

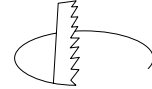
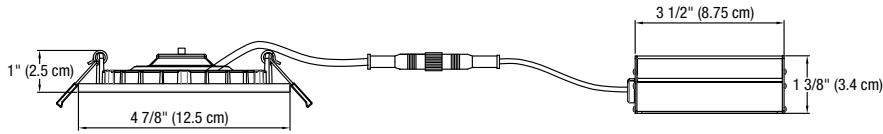

Ø 4 1/4" (108mm)

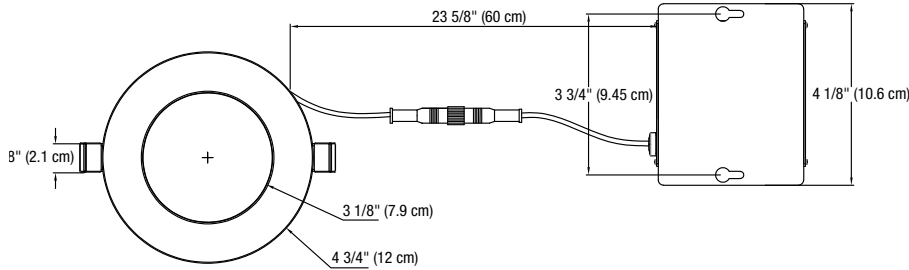

6"

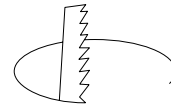
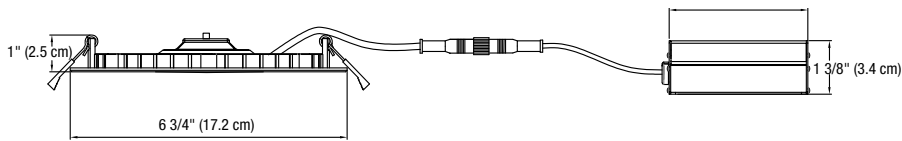

Ø 6 1/4" (159 mm)

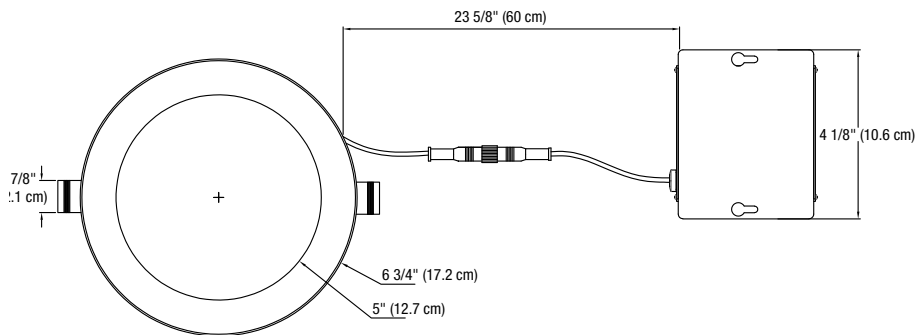

Accessories

| Order code | Model number | Opening diameter (in.) | Type | Case qty (master) |
|------------|---------------------------------|------------------------|---------------------------------|-------------------|
| 66051 | ACC/MPLATE/4.25IN/SQR/STD | 4 1/4 | Square mounting plate | 100 |
| 66058 | ACC/MPLATE/4.25IN/ADJ/STD | 4 1/4 | Adjustable mounting plate | 50 |
| 66821 | ACC/MPLATE/4.25IN/HANG.BARS/STD | 4 1/4 | Mounting plate with hanger bars | 25 |
| 66143 | ACC/4/VAPOR BARRIER/STD | 4 1/4 | Vapor barrier extender | 50 |
| 66822 | ACC/MPLATE/6.25IN/HANG.BARS/STD | 6 1/4 | Mounting plate with hanger bars | 25 |
| 64263 | ACC/MPLATE/6.25IN/SQR/STD | 6 1/4 | Square mounting plate | 96 |
| 64921 | ACC/MPLATE/6.25IN/ADJ/STD | 6 1/4 | Adjustable mounting plate | 24 |
| 66144 | ACC/6/VAPOR BARRIER/STD | 6 7/32 | Vapor barrier extender | 50 |
| 64264 | LPDL/ACC/6FT/EXTCABLE/STD | - | 6' extension cord | 96 |

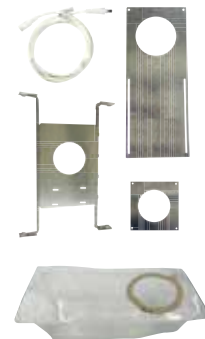

Lumen values are derived from photometric testing
For a complete list of compatible dimmers and ENERGY STAR qualified products, please visit www.standardpro.com



Swivel LED Downlight



The LED SWIVEL Choice downlight has been specially designed to highlight specific zones by offering 360° rotation with a 90° tilt. Featuring great performance and quality with a CRI of 90+, this 4" directional downlight is easy to install in any type of ceiling. The LED SWIVEL Choice downlight is a cost-effective solution for all residential applications.

| Order code | Model number | Watts (W) | Volts (VAC) | Color temp. (K) | Lumen output (lm) | Efficiency (lm/W) | CRI | Life L70 (hrs) | Beam angle (°) | Cable rating | Finish | Dimming (Yes/No) | Power factor | THD (%) | Case qty (master) |
|-----------------------|-----------------------|-----------|-------------|-------------------|-------------------|-------------------|-----|----------------|----------------|--------------|----------------|------------------|--------------|---------|-------------------|
| Single CCT | | | | | | | | | | | | | | | |
| 68508 | SWDL4R-9A-30WH/CHOICE | 9 | 120 | 3 000 | 750 | 83 | 90+ | 50 000 | 45 | FT4 | White | Yes | >0.9 | <15 | 32 |
| CCT Selectable | | | | | | | | | | | | | | | |
| 68671 | SWDL4R-8A-3CWH/CHOICE | 8 | 120 | 2 700/3 000/4 000 | 600 | 75 | 90+ | 50 000 | 45 | FT4 | White | Yes | >0.9 | <15 | 32 |
| 68672 | SWDL4R-8A-3CBK/CHOICE | 8 | 120 | 2 700/3 000/4 000 | 600 | 75 | 90+ | 50 000 | 45 | FT4 | Black | Yes | >0.9 | <15 | 32 |
| 68673 | SWDL4R-8A-3CBN/CHOICE | 8 | 120 | 2 700/3 000/4 000 | 600 | 75 | 90+ | 50 000 | 45 | FT4 | Brushed Nickel | Yes | >0.9 | <15 | 32 |

Dimensions



Single CCT

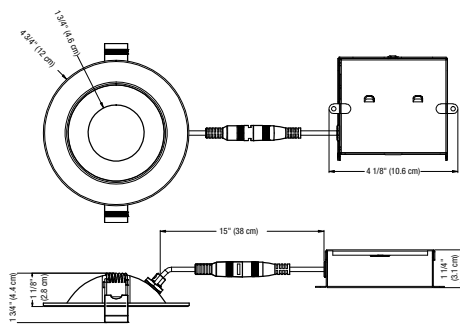

CCT Selectable

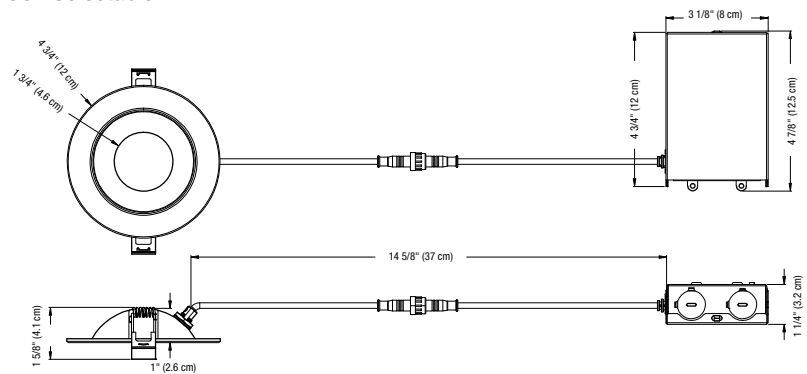

Accessories

| Order code | Model number | Opening diameter (in.) | Type | Case qty (master) |
|--------------------|---------------------------|------------------------|---------------------------|-------------------|
| 66050 ¹ | ACC/MPLATE/3.75IN/SQR/STD | 3 3/4 | Square mounting plate | 96 |
| 66057 ¹ | ACC/MPLATE/3.75IN/ADJ/STD | 3 3/4 | Adjustable mounting plate | 24 |
| 64264 ² | LPDL/ACC/6FT/EXTCABLE/STD | - | 6' Extension cord | 96 |

¹ Includes brackets and screws.

² Only compatible with 68508.

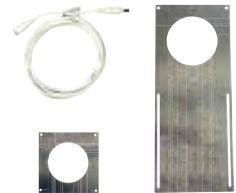

Lumen values are derived from photometric testing
For a complete list of compatible dimmers and ENERGY STAR qualified products, please visit www.standardpro.com





LED Panel

Our Choice LED Panels operate from 100 V to 277 V. The sleek and modern design is easily and quickly installed. The Choice commercial grade panels are the perfect solution to meet required light levels in any application. LED Choice Panels are perfect for offices, schools and commercial buildings.

- Consistent even dimming you can depend on. Dimmable 0-10V
- Designed to fit seamlessly into existing T-bar systems or alternatively can be surface-mounted or suspended for a unique look
- LED Choice panels are offered in a variety of color temperatures 3500 K, 4000 K and 5000 K
- Ideal replacement for traditional fluorescent fixtures, offering a uniform light and minimal glare



1' x 4'



2' x 2'



2' x 4'

| Order code | Description | Watts (W) | Volts (VAC) | Color temp. (K) | Lumen output (lm) | CRI | Life L70 (hrs) | Case qty (master) |
|----------------|-----------------------------------|-----------|-------------|-----------------|-------------------|-----|----------------|-------------------|
| 1' x 4' | | | | | | | | |
| 67151 | PAN1X4/100-277/40W/35K/CHOICE/STD | 40 | 100-277 | 3 500 | 4 102 | 82 | 50 000 | 2 |
| 67152 | PAN1X4/100-277/40W/40K/CHOICE/STD | 40 | 100-277 | 4 000 | 4 235 | 82 | 50 000 | 2 |
| 2' x 2' | | | | | | | | |
| 67154 | PAN2X2/100-277/40W/35K/CHOICE/STD | 40 | 100-277 | 3 500 | 4 105 | 82 | 50 000 | 4 |
| 67155 | PAN2X2/100-277/40W/40K/CHOICE/STD | 40 | 100-277 | 4 000 | 4 178 | 82 | 50 000 | 4 |
| 67156 | PAN2X2/100-277/40W/50K/CHOICE/STD | 40 | 100-277 | 5 000 | 4 323 | 83 | 50 000 | 4 |
| 2' x 4' | | | | | | | | |
| 67158 | PAN2X4/100-277/50W/40K/CHOICE/STD | 50 | 100-277 | 4 000 | 5 312 | 83 | 50 000 | 2 |

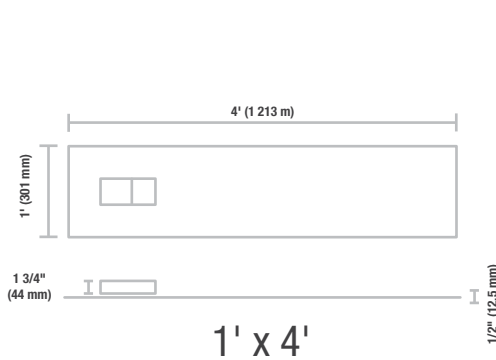

1' x 4'

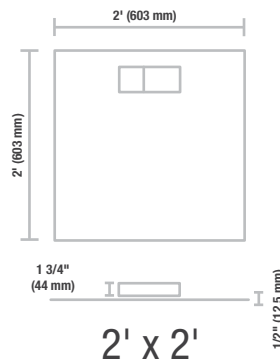

2' x 2'

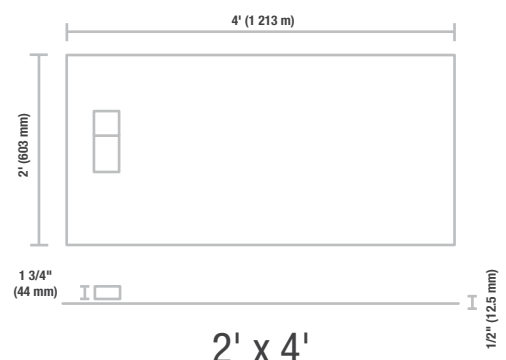

2' x 4'

Accessories

| Order code | Description | Type |
|------------|---------------------------------|-------------------|
| 64825 | LPAN/ACC/2X2/SMK/STD | Surface mount kit |
| 64826 | LPAN/ACC/1X4/SMK/STD | Surface mount kit |
| 64827 | LPAN/ACC/2X4/SMK/STD | Surface mount kit |
| 64828 | LPAN/ACC/2X2/SUSPENSION/STD | Suspension cable |
| 64829 | LPAN/ACC/1X4_2X4/SUSPENSION/STD | Suspension cable |
| 63490 | DRYWALL KIT FOR 1X4 FRT/STD | Drywall kit |
| 67164 | DRYWALL KIT FOR 2X2 | Drywall kit |
| 63491 | DRYWALL KIT FOR 2X4 FRT/STD | Drywall kit |

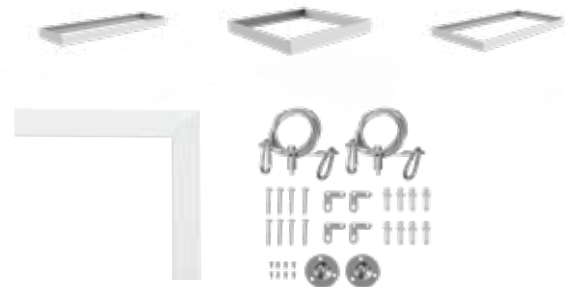

Lumen values are derived from photometric testing
For a complete list of compatible dimmers and DLC qualified products, please visit www.standardpro.com





LED Mini Flood

STANDARD's Choice LED Mini Flood Luminaires create bright, shadow-free security and ambient lighting for a variety of outdoor applications, including facades, landscapes, public places and residential complexes. They are offered in multiple wattages to fit both residential and commercial uses, and have a wide flood distribution for a large and uniform light pattern.



A



B



C



D



E



F



G



H

| Order code | Description | Watts | Volts | Color temp. | CRI | Life L70 | Lumen output | Finish | Figure | Traditional equivalent (W) | | Case qty (master) |
|------------|-------------|-------|-------|-------------|-------|----------|--------------|--------|--------|----------------------------|--|-------------------|
| | | (W) | (VAC) | (K) | (hrs) | (lm) | MH | | | HPS | | |

Knuckle

| | | | | | | | | | | | | |
|-------|-----------------------------|----|-----|-------|----|--------|-------|-------|---|-----|-----|----|
| 67300 | FL/10W/30K/KN/BK/CHOICE/STD | 10 | 120 | 3 000 | 80 | 50 000 | 1 063 | Black | A | 50 | 35 | 60 |
| 67223 | FL/10W/40K/KN/BK/CHOICE/STD | 10 | 120 | 4 000 | 80 | 50 000 | 1 069 | Black | A | 50 | 35 | 60 |
| 67301 | FL/20W/30K/KN/BK/CHOICE/STD | 20 | 120 | 3 000 | 80 | 50 000 | 1 803 | Black | B | 70 | 70 | 40 |
| 67302 | FL/30W/30K/KN/BK/CHOICE/STD | 30 | 120 | 3 000 | 80 | 50 000 | 3 087 | Black | C | 100 | 70 | 20 |
| 67229 | FL/50W/40K/KN/BK/CHOICE/STD | 50 | 120 | 4 000 | 80 | 50 000 | 5 397 | Black | D | 175 | 150 | 20 |

Yoke

| | | | | | | | | | | | | |
|-------|-----------------------------|----|-----|-------|----|--------|-------|-------|---|-----|-----|----|
| 67224 | FL/10W/40K/YK/BK/CHOICE/STD | 10 | 120 | 4 000 | 80 | 50 000 | 1 069 | Black | E | 50 | 35 | 60 |
| 67226 | FL/20W/40K/YK/BK/CHOICE/STD | 20 | 120 | 4 000 | 80 | 50 000 | 1 870 | Black | F | 70 | 70 | 30 |
| 67228 | FL/30W/40K/YK/BK/CHOICE/STD | 30 | 120 | 4 000 | 80 | 50 000 | 3 191 | Black | G | 100 | 70 | 20 |
| 67230 | FL/50W/40K/YK/BK/CHOICE/STD | 50 | 120 | 4 000 | 80 | 50 000 | 5 397 | Black | H | 175 | 150 | 10 |

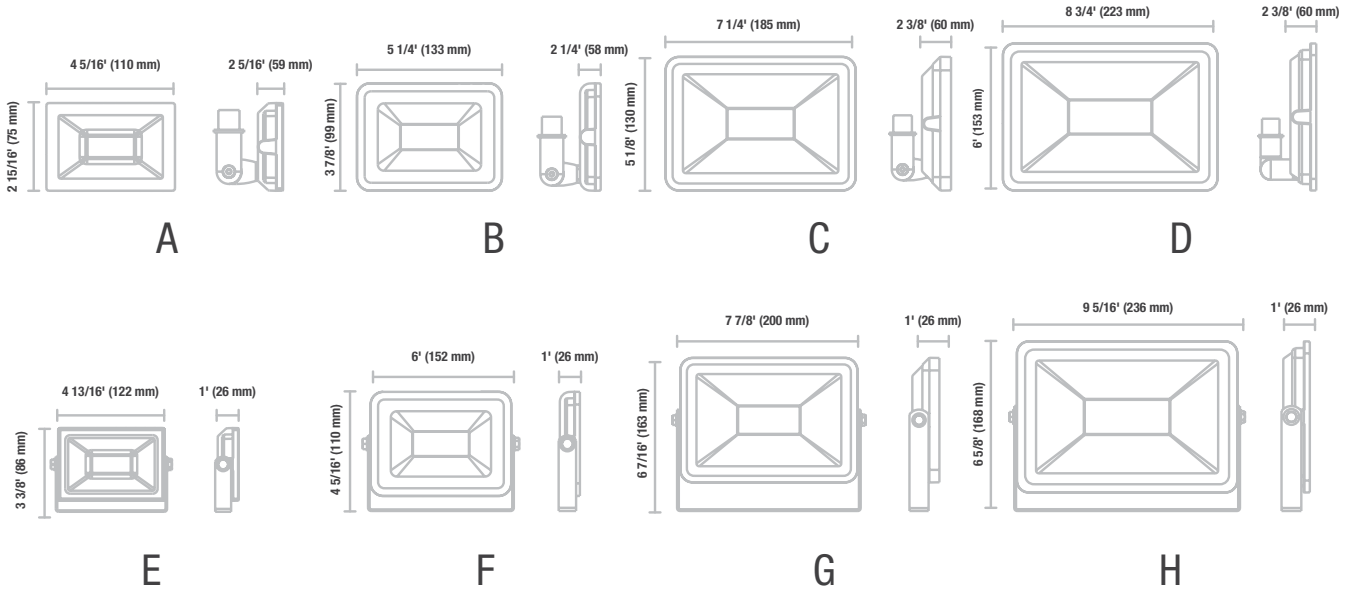

Lumen values are derived from photometric testing
For a complete list of DLC qualified products, please visit www.standardpro.com





E-Lume™

STANDARD offers a variety of products within its E-Lume™ brand, providing a good balance between great value and excellent performance.

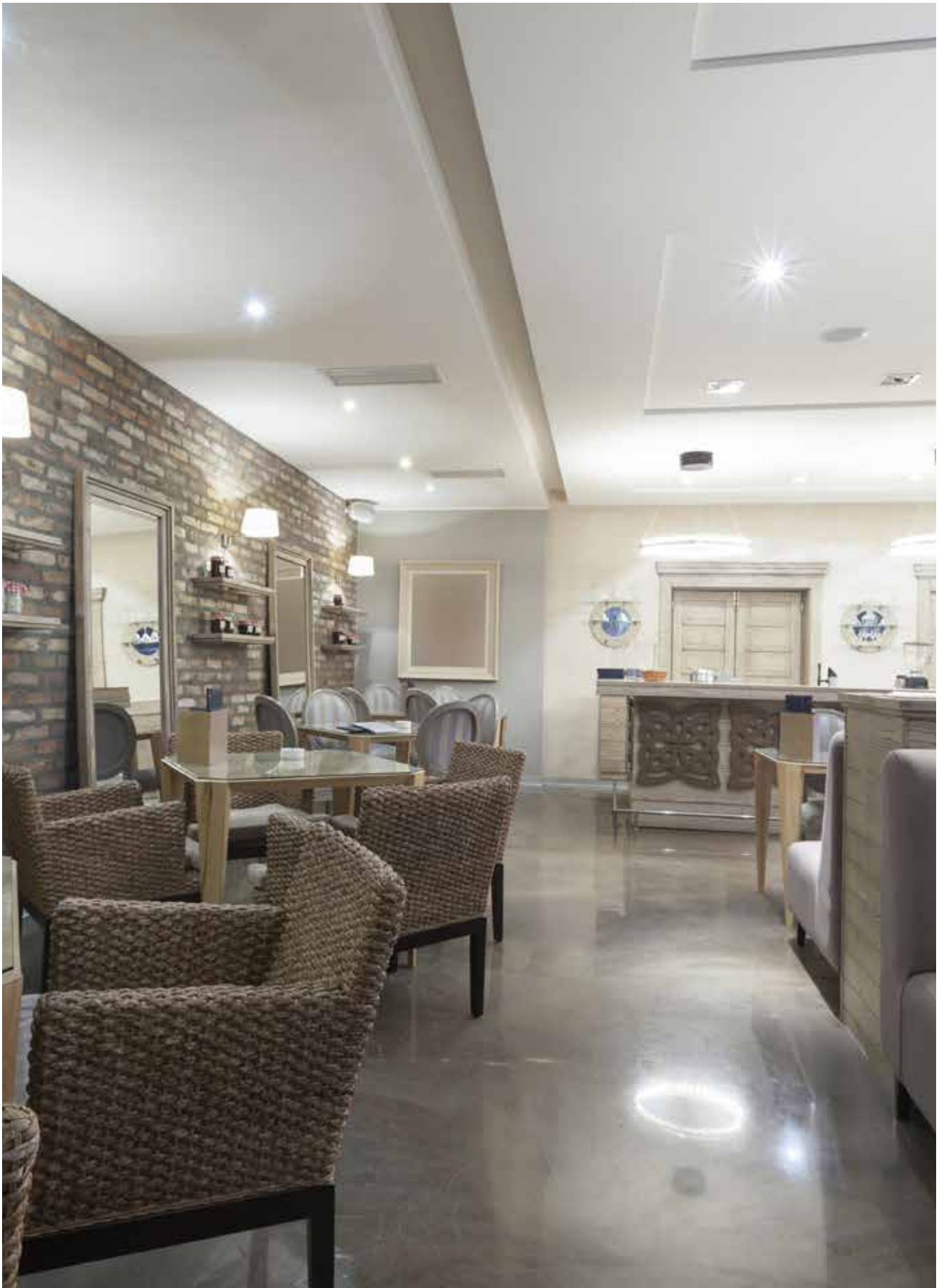

Recessed Fixture

The E-Lume™ Recessed Fixtures line is composed of airtight housings and of a variety of trims, offering different designs and finishes.

4 1/4" Housings



| Order code | Description | Opening diameter (in.) | Volts (VAC) | Socket | Case qty (master) |
|---------------------------------------|----------------------------------|------------------------|-------------|--------|-------------------|
| Remodeler - IC Airtight | | | | | |
| 64359 ^{2,4} | RF4in/REMOD/IC/LED/E26/ELUME | 4 1/4 | 120 | E26 | 6 |
| 64360 ^{1,4} | RF4in/REMOD/IC/LED/GU10/ELUME | 4 1/4 | 120 | GU10 | 6 |
| New Construction - IC Airtight | | | | | |
| 64361 ^{1,4} | RF4in/NC/IC/NOBOX/LED/GU10/ELUME | 4 1/4 | 120 | GU10 | 6 |
| 64362 ^{2,4} | RF4in/NC/IC/NOBOX/LED/E26/ELUME | 4 1/4 | 120 | E26 | 6 |
| New Construction - IC Airtight | | | | | |
| 64363 ³ | RF4in/NC/IC/E26/ELUME | 4 1/4 | 120 | E26 | 6 |
| 64364 ³ | RF4in/NC/IC/GU10/ELUME | 4 1/4 | 120 | GU10 | 6 |

4 1/4" Trims

Compatible Lamp (PAR20)



| Order code | Description | Finish | Rotation angle (°) | Case qty (master) |
|--------------------|------------------------------------|------------------------|--------------------|-------------------|
| Deep Baffle | | | | |
| 64376 | RF4/TRIM/DB/BLK/PAR20/ELUME | Black | N/A | 24 |
| 64377 | RF4/TRIM/DB/BLK_BR.NKL/PAR20/ELUME | Black / Brushed Nickel | N/A | 24 |
| 64378 | RF4/TRIM/DB/WH/PAR20/ELUME | White | N/A | 24 |
| Gimbal | | | | |
| 64379 | RF4/TRIM/GMB/BLK/PAR20/ELUME | Black | 30 | 12 |
| 64381 | RF4/TRIM/GMB/BR.NKL/PAR20/ELUME | Brushed Nickel | 30 | 12 |
| 64383 | RF4/TRIM/GMB/WH/PAR20/ELUME | White | 30 | 12 |
| 64384 | RF4/TRIM/GMB/BRZ/PAR20/ELUME | Bronze | 30 | 12 |
| Reflector | | | | |
| 64372 | RF4/TRIM/RFL_BLK/PAR20/ELUME | Black | N/A | 24 |
| 64373 | RF4/TRIM/RFL_WH/PAR20/ELUME | White | N/A | 24 |
| 64374 | RF4/TRIM/RFL_BR.NKL/PAR20/ELUME | Brushed Nickel | N/A | 24 |

For complete warranty information please visit www.standardpro.com
⁴ Only valid with LED lamps



4 1/4" Trims

Compatible Lamp (MR16 GU10, MR16 E26, PAR16)

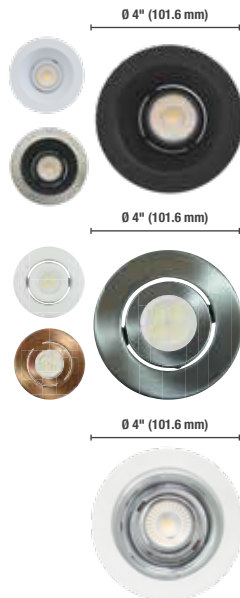

| Order code | Model number | Finish | Rotation angle (°) | Case qty (master) |
|-----------------------------|---------------------------------------|------------------------|--------------------|-------------------|
| Deep Baffle - Gimbal | | | | |
| 64370 | RF4/TRIM/GMB.DB/BLK/MR16/ELUME | Black | 30 | 24 |
| 64371 | RF4/TRIM/GMB.DB/BLK_BR.NKL/MR16/ELUME | Black / Brushed Nickel | 30 | 24 |
| 64375 | RF4/TRIM/GMB.DB/WH/MR16/ELUME | White | 30 | 24 |
| Gimbal | | | | |
| 64380 | RF4/TRIM/GMB/BR.NKL/MR16/ELUME | Brushed Nickel | 30 | 12 |
| 64382 | RF4/TRIM/GMB/WH/MR16/ELUME | White | 30 | 12 |
| 64385 | RF4/TRIM/GMB/BRZ/MR16/ELUME | Bronze | 30 | 12 |
| Reflector - Gimbal | | | | |
| 65548 | RF4/TRIM/GMB.DB/RFL_WH/MR16/ELUME | Chrome / White | 30 | 24 |
| 66751 | F4/TRIM/GMB.DB_SLEEK/WH/MR16/ELUME | White | 30 | 24 |

4 1/4" Shower Trims

Compatible Lamp² (PAR20)

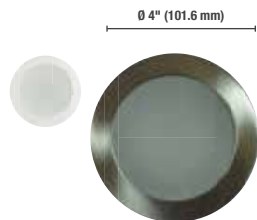

| Order code | Description | Finish | Rotation angle (°) | Case qty (master) |
|--------------------|---------------------------------|----------------|--------------------|-------------------|
| Shower | | | | |
| 64387 ¹ | RF4/TRIM/SWR/BR.NKL/PAR20/ELUME | Brushed Nickel | N/A | 24 |
| 64389 ¹ | RF4/TRIM/SWR/WH/PAR20/ELUME | White | N/A | 24 |

4 1/4" Shower Trims

Compatible Lamp² (MR16 GU10, MR16 E26, PAR16)

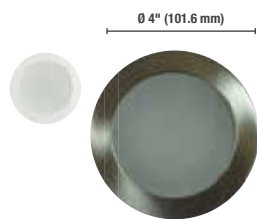

| Order code | Description | Finish | Rotation angle (°) | Case qty (master) |
|--------------------|--------------------------------|----------------|--------------------|-------------------|
| Shower | | | | |
| 64386 ¹ | RF4/TRIM/SWR/BR.NKL/MR16/ELUME | Brushed Nickel | N/A | 24 |
| 64388 ¹ | RF4/TRIM/SWR/WH/MR16/ELUME | White | N/A | 24 |

Accessories

| Order code | Description | Opening diameter (in.) | Type | Case qty (master) |
|------------|---------------------------------------|------------------------|---------------------------------|-------------------|
| 66052 | RF/ACC/4.5/MOUNT. PLATE/SQR/STD | 4 1/2 | Square mounting plate | 50 |
| 62772 | RF/ACC/4.5/MOUNT. PLATE/HANG.BARS/STD | 4 1/2 | Mounting plate with hanger bars | 25 |
| 62679 | ACC/VAPOR BARRIER/STD | - | Vapor barrier extender | 25 |
| 66143 | ACC/4/VAPOR BARRIER/STD | 4 1/4 | Vapor barrier extender | 50 |

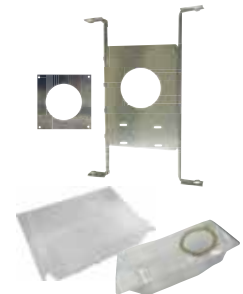

¹ Notes: Not recommended for use in steam showers or when directly exposed to water

² Enclosed fixtures may reduce the LED or CFL lamp life



Incandescent Lamp



BR30



G16.5



G25



R16



R20

| Order code | Description | Watts (W) | Base | Volts (VAC) | Finish | Filament | Life L70 (hrs) | Lumen output (lm) | LCL (in.) | LCL (mm) | Case qty (inner/master) |
|--------------|---------------------------------|-----------|------|-------------|------------|----------|----------------|-------------------|-----------|----------|-------------------------|
| BR30 | | | | | | | | | | | |
| 52452 | 65BR30/FL/5M/ES/130V/ELUME 2P | 65 | E26 | 130 | Frost | CC-6 | 5 000 | 590 | 4 | 101 | 12/60 |
| G16.5 | | | | | | | | | | | |
| 52453 | 25G16.5/CL/3M/E12/130V/ELUME 2P | 25 | E12 | 130 | Clear | C-7A | 3 000 | 160 | 1 7/8 | 48 | 24/120 |
| 52454 | 40G16.5/CL/3M/E12/130V/ELUME 2P | 40 | E12 | 130 | Clear | C-7A | 3 000 | 315 | 1 7/8 | 48 | 24/120 |
| G25 | | | | | | | | | | | |
| 52455 | 40G25/CL/3M/130V/ELUME 2P | 40 | E26 | 130 | Clear | C-9 | 3 000 | 350 | 2 7/8 | 73 | 12/60 |
| 52457 | 40G25/WH/3M/130V/ELUME 2P | 40 | E26 | 130 | White | C-9 | 3 000 | 330 | 2 7/8 | 73 | 12/60 |
| R16 | | | | | | | | | | | |
| 52459 | 40R16/SW/1M/120V/ELUME 2P | 40 | E26 | 120 | Soft White | CC-6 | 1 000 | 445 | 3 1/32 | 77 | 12/60 |
| 52460 | 60R16/SW/1M/130V/ELUME 2P | 60 | E26 | 130 | Soft White | CC-6 | 1 000 | 730 | 3 1/32 | 77 | 12/60 |
| R20 | | | | | | | | | | | |
| 52462 | 30R20/FL/5M/130V/ELUME 2P | 30 | E26 | 130 | Frost | C-9 | 5 000 | 135 | 2 9/16 | 65 | 12/60 |
| 61707 | 45R20/FL/5M/130V/ELUME 2P | 45 | E26 | 130 | Frost | CC-6 | 5 000 | 242 | 2 9/16 | 65 | 12/60 |

CFL Lamp



PAR20



T2



4 pack



12 pack

| Order code | Description | Watts (W) | Base | Color temp. (K) | CRI | Life L70 (hrs) | Lumen output (lm) | Traditional equivalent (W) Incandescent | Case qty (master) |
|-------------------------|----------------------------------|--------------|------|--------------------|-----|-------------------|----------------------|--|----------------------|
| PAR20 | | | | | | | | | |
| 59674 | CF9/41K/PAR20/E26/ELUME | 9 | E26 | 4 100 | 82 | 8 000 | 300 | 50 | 6/48 |
| T2 Spirals | | | | | | | | | |
| 62764 | CF7/T2/27K/SPIRAL/E26/ELUME | 7 | E26 | 2 700 | 82 | 10 000 | 430 | 40 | 6/48 |
| 61020 | CF9/T2/27K/SPIRAL/E26/ELUME | 9 | E26 | 2 700 | 82 | 10 000 | 550 | 40 | 6/48 |
| 62311 | CF9/T2/41K/SPIRAL/E26/ELUME | 9 | E26 | 4 100 | 82 | 10 000 | 550 | 40 | 6/48 |
| 62765 | CF11/T2/27K/SPIRAL/E26/ELUME | 11 | E26 | 2 700 | 82 | 10 000 | 730 | 40 | 6/48 |
| 61021 | CF13/T2/27K/SPIRAL/E26/ELUME | 13 | E26 | 2 700 | 82 | 10 000 | 900 | 60 | 6/48 |
| 61024 | CF13/T2/30K/SPIRAL/E26/ELUME | 13 | E26 | 3 000 | 82 | 10 000 | 900 | 60 | 6/48 |
| 61026 | CF13/T2/35K/SPIRAL/E26/ELUME | 13 | E26 | 3 500 | 82 | 10 000 | 850 | 60 | 6/48 |
| 61031 | CF20/T2/27K/SPIRAL/E26/ELUME | 20 | E26 | 2 700 | 82 | 10 000 | 1 330 | 75 | 6/48 |
| 61032 | CF23/T2/27K/SPIRAL/E26/ELUME | 23 | E26 | 2 700 | 82 | 10 000 | 1 600 | 100 | 6/48 |
| 61033 | CF23/T2/30K/SPIRAL/E26/ELUME | 23 | E26 | 3 000 | 82 | 10 000 | 1 600 | 100 | 6/48 |
| 61034 | CF23/T2/41K/SPIRAL/E26/ELUME | 23 | E26 | 4 100 | 82 | 10 000 | 1 600 | 100 | 6/48 |
| 61035 | CF23/T2/50K/SPIRAL/E26/ELUME | 23 | E26 | 5 000 | 82 | 10 000 | 1 600 | 100 | 6/48 |
| T2 Spirals packs | | | | | | | | | |
| 61022 | CF13/T2/27K/SPIRAL/E26/ELUME 4P | 13 | E26 | 2 700 | 82 | 10 000 | 900 | 60 | 1/64 |
| 61025 | CF13/T2/30K/SPIRAL/E26/ELUME 4P | 13 | E26 | 3 000 | 82 | 10 000 | 900 | 60 | 1/64 |
| 61027 | CF13/T2/41K/SPIRAL/E26/ELUME 4P | 13 | E26 | 4 100 | 82 | 10 000 | 880 | 60 | 1/64 |
| 61023 | CF13/T2/27K/SPIRAL/E26/ELUME 12P | 13 | E26 | 2 700 | 82 | 10 000 | 900 | 60 | 1/48 |

CFL Lamp



2-pin Double
Twin Tube



4-pin Double
Twin Tube

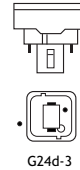

G24d-3

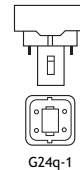

G24q-1

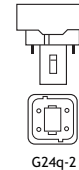

G24q-2

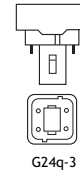

G24q-3

2-pin

4-pin

| Order code | Description | Watts (W) | Base | Color temp. (K) | CRI | Life L70 (hrs) | Lumen output (lm) | MOL (in.) (mm) | Case qty (master) |
|-------------------------------|-----------------------|-----------|--------|-----------------|-----|----------------|-------------------|---------------------------------|-------------------|
| 2-pin Double Twin Tube | | | | | | | | | |
| 14113 | PL26/27K/DTT/2P/ELUME | 26 | G24d-3 | 2 700 | 82 | 10 000 | 1 540 | 6 ¹³ / ₁₆ | 6/96 |
| 14114 | PL26/35K/DTT/2P/ELUME | 26 | G24d-3 | 3 500 | 82 | 10 000 | 1 540 | 6 ¹³ / ₁₆ | 6/96 |
| 4-pin Double Twin Tube | | | | | | | | | |
| 14117 | PL13/30K/DTT/4P/ELUME | 13 | G24q-1 | 3 000 | 82 | 10 000 | 810 | 5 ⁵ / ₃₂ | 6/96 |
| 14120 | PL18/30K/DTT/4P/ELUME | 18 | G24q-2 | 3 000 | 82 | 10 000 | 1 035 | 5 ²⁵ / ₃₂ | 6/96 |

HID Lamp



BD17

| Order code | Description | Watts (W) | Base | Shape | Color temp. (K) | ANSI code | CRI | Life L70 (hrs) | Lumen output (lm) | Mean lumens (lm) | Burn pos. | Finish | Luminaire | Case qty (master) |
|--------------------|---------------------|-----------|------|-------|-----------------|-----------|-----|----------------|-------------------|------------------|-----------|--------|-----------|-------------------|
| Pulse Start | | | | | | | | | | | | | | |
| 58514 | MH70W/C/U/PS/ELUME | 70 | E26 | BD17 | 3 700 | M98 | 70 | 15 000 | 5 300 | 3 400 | U | Coated | Enclosed | 24 |
| 58517 | MH100W/C/U/PS/ELUME | 100 | E26 | BD17 | 3 700 | M90 | 70 | 15 000 | 8 500 | 5 500 | U | Coated | Enclosed | 24 |

Fluorescent Lamp



| Order code | Description | Watts (W) | Base | Color temp. (K) | CRI | Rated life IS 3-12 hrs ² | Lumen output (lm) | Mean lumens (lm) | Nominal length (in.) (mm) | Efficacy (lm/W) | Case qty (master) |
|-------------------------|-----------------------|-----------|-----------|-----------------|-----|-------------------------------------|-------------------|------------------|---------------------------|-----------------|-------------------|
| T8 Preheat Start | | | | | | | | | | | |
| 56514 ¹ | F15T8/CW/PH/G13/ELUME | 15 | Med Bipin | 4 100 | 62 | 6 000-7 500 | 610 | 573 | 18 457 | 41 | 48 |
| 56515 ¹ | F15T8/DL/PH/G13/ELUME | 15 | Med Bipin | 6 500 | 72 | 6 000-7 500 | 560 | 526 | 18 457 | 37 | 48 |

| Order code | Description | Watts (W) | Base | Color temp. (K) | CRI | Rated life IS 3-12 hrs ² | Rated life PS/PRS 3-12 hrs ² | Lumen output (lm) | Mean lumens (lm) | Nominal length (in.) (mm) | Efficacy (lm/W) | Case qty (master) |
|------------------------------------|-------------------------------|-----------|-----------|-----------------|-----|-------------------------------------|---|-------------------|------------------|---------------------------|-----------------|-------------------|
| T8 800 Series - Rapid Start | | | | | | | | | | | | |
| 62513 ¹ | F32T8/35K/8/RS/G13/ELUME/BULK | 32 | Med Bipin | 3 500 | 85 | 24 000-30 000 | 40 000-42 000 | 3 050 | 2 900 | 48 1 220 | 95 | 25 |
| 62514 ¹ | F32T8/41K/8/RS/G13/ELUME/BULK | 32 | Med Bipin | 4 100 | 85 | 24 000-30 000 | 40 000-42 000 | 3 000 | 2 850 | 48 1 220 | 94 | 25 |
| 62515 ¹ | F32T8/50K/8/RS/G13/ELUME/BULK | 32 | Med Bipin | 5 000 | 85 | 24 000-30 000 | 40 000-42 000 | 2 950 | 2 800 | 48 1 220 | 92 | 25 |
| 62516 ¹ | F32T8/65K/8/RS/G13/ELUME/BULK | 32 | Med Bipin | 6 500 | 85 | 24 000-30 000 | 40 000-42 000 | 2 900 | 2 750 | 48 1 220 | 91 | 25 |



| Order code | Description | Watts (W) | Base | Color temp. (K) | CRI | Rated life IS 3-12 hrs ² | Lumen output (lm) | Mean lumens (lm) | Nominal length (in.) (mm) | Efficacy (lm/W) | Case qty (master) |
|-------------------------|----------------------|-----------|-----------|-----------------|-----|-------------------------------------|-------------------|------------------|---------------------------|-----------------|-------------------|
| T5 Preheat Start | | | | | | | | | | | |
| 56510 | F6T5/CW/PH/G5/ELUME | 6 | Min Bipin | 4 100 | 62 | 6 000-7 500 | 240 | 225 | 9 229 | 40 | 48 |
| 56511 | F6T5/DL/PH/G5/ELUME | 6 | Min Bipin | 6 500 | 62 | 6 000-7 500 | 210 | 197 | 9 229 | 35 | 48 |
| 56512 | F8T5/CW/PH/G5/ELUME | 8 | Min Bipin | 4 100 | 62 | 6 000-7 500 | 350 | 329 | 12 305 | 44 | 48 |
| 56513 | F8T5/DL/PH/G5/ELUME | 8 | Min Bipin | 6 500 | 62 | 6 000-7 500 | 310 | 291 | 12 305 | 39 | 48 |
| 56518 | F13T5/WW/PH/G5/ELUME | 13 | Min Bipin | 3 000 | 62 | 6 000-7 500 | 800 | 752 | 21 530 | 62 | 48 |
| 57392 | F13T5/CW/PH/G5/ELUME | 13 | Min Bipin | 4 100 | 62 | 6 000-7 500 | 740 | 695 | 21 530 | 57 | 48 |

¹TCLP compliant

² Based on a 3 hour and 12 hour start

IS=Instant Start ballast

PS=Program Start ballast

PRS=Program Rapid Start ballast

| Order code | Description | Watts (W) | Base | Color temp. (K) | CRI | Rated life PS/PRS 3-12 hrs ² | Lumen output (lm) | Mean lumens (lm) | Nominal length (in.) (mm) | Efficacy (lm/W) | Case qty (master) |
|------------|-------------|-----------|------|-----------------|-----|---|-------------------|------------------|---------------------------|-----------------|-------------------|
|------------|-------------|-----------|------|-----------------|-----|---|-------------------|------------------|---------------------------|-----------------|-------------------|

T5 Program Start

| | | | | | | | | | | | |
|--------------------|-------------------------|----|-----------|-------|----|---------------|-------|-------|----------|-----|----|
| 59187 ¹ | F14T5/35K/8/PS/G5/ELUME | 14 | Min Bipin | 3 500 | 85 | 24 000-30 000 | 1 350 | 1 280 | 22 559 | 96 | 25 |
| 59188 ¹ | F14T5/41K/8/PS/G5/ELUME | 14 | Min Bipin | 4 100 | 85 | 24 000-30 000 | 1 350 | 1 280 | 22 559 | 96 | 25 |
| 59189 ¹ | F14T5/50K/8/PS/G5/ELUME | 14 | Min Bipin | 5 000 | 85 | 24 000-30 000 | 1 300 | 1 230 | 22 559 | 93 | 25 |
| 59190 ¹ | F21T5/35K/8/PS/G5/ELUME | 21 | Min Bipin | 3 500 | 85 | 24 000-30 000 | 2 100 | 2 000 | 34 864 | 100 | 25 |
| 59191 ¹ | F21T5/41K/8/PS/G5/ELUME | 21 | Min Bipin | 4 100 | 85 | 24 000-30 000 | 2 100 | 2 000 | 34 864 | 100 | 25 |
| 59192 ¹ | F21T5/50K/8/PS/G5/ELUME | 21 | Min Bipin | 5 000 | 85 | 24 000-30 000 | 2 100 | 2 000 | 34 864 | 100 | 25 |
| 59196 ¹ | F28T5/35K/8/PS/G5/ELUME | 28 | Min Bipin | 3 500 | 85 | 24 000-30 000 | 2 900 | 2 750 | 46 1 168 | 104 | 25 |
| 59197 ¹ | F28T5/41K/8/PS/G5/ELUME | 28 | Min Bipin | 4 100 | 85 | 24 000-30 000 | 2 900 | 2 750 | 46 1 168 | 104 | 25 |
| 59198 ¹ | F28T5/50K/8/PS/G5/ELUME | 28 | Min Bipin | 5 000 | 85 | 24 000-30 000 | 2 750 | 2 610 | 46 1 168 | 98 | 25 |

T5 HO Program Start

| | | | | | | | | | | | |
|--------------------|----------------------------|----|-----------|-------|----|---------------|-------|-------|----------|----|----|
| 59193 ¹ | F24T5/35K/8/HO/PS/G5/ELUME | 24 | Min Bipin | 3 500 | 85 | 24 000-30 000 | 2 000 | 1 900 | 22 559 | 83 | 25 |
| 59194 ¹ | F24T5/41K/8/HO/PS/G5/ELUME | 24 | Min Bipin | 4 100 | 85 | 24 000-30 000 | 2 000 | 1 900 | 22 559 | 83 | 25 |
| 59195 ¹ | F24T5/50K/8/HO/PS/G5/ELUME | 24 | Min Bipin | 5 000 | 85 | 24 000-30 000 | 1 900 | 1 805 | 22 559 | 79 | 25 |
| 59201 ¹ | F39T5/50K/8/HO/PS/G5/ELUME | 39 | Min Bipin | 5 000 | 85 | 24 000-30 000 | 3 500 | 3 325 | 34 864 | 90 | 25 |
| 65494 | F54T5/35K/8/HO/PS/G5/ELUME | 54 | Min Bipin | 3 500 | 85 | 35 000-40 000 | 5 000 | 4 651 | 46 1 168 | 83 | 25 |
| 65495 | F54T5/41K/8/HO/PS/G5/ELUME | 54 | Min Bipin | 4 100 | 85 | 35 000-40 000 | 5 000 | 4 450 | 46 1 168 | 93 | 25 |
| 65497 | F54T5/50K/8/HO/PS/G5/ELUME | 54 | Min Bipin | 5 000 | 85 | 35 000-40 000 | 4 900 | 4 465 | 46 1 168 | 77 | 25 |



Ø 1 5/32" (29.5 mm)

| Order code | Description | Watts (W) | Base | Color temp. (K) | CRI | Life L70 (hrs) | Lumen output (lm) | Mean lumens (lm) | Nominal length (in.) (mm) | Efficacy (lm/W) | Case qty (master) |
|------------|-------------|-----------|------|-----------------|-----|----------------|-------------------|------------------|---------------------------|-----------------|-------------------|
|------------|-------------|-----------|------|-----------------|-----|----------------|-------------------|------------------|---------------------------|-----------------|-------------------|

CIRCLINE Rapid Start

| | | | | | | | | | | | |
|-------|-----------------------|----|----------------|-------|----|--------|-------|-------|--------|----|----|
| 56516 | FC8T9/CW/RS/4P/ELUME | 22 | Circline 4-Pin | 4 100 | 60 | 12 000 | 1 150 | 1 095 | 9 229 | 52 | 24 |
| 56517 | FC12T9/CW/RS/4P/ELUME | 32 | Circline 4-Pin | 4 100 | 85 | 12 000 | 1 570 | 1 495 | 12 305 | 49 | 24 |

¹TCLP compliant

² Based on a 3 hour and 12 hour start

IS=Instant Start ballast

PS=Program Start ballast

PRS=Program Rapid Start ballast

